

Article number: 20194V50B502SW

Description: E+G

T-angel clamps GN194-V50-B50-2-SW

Measures

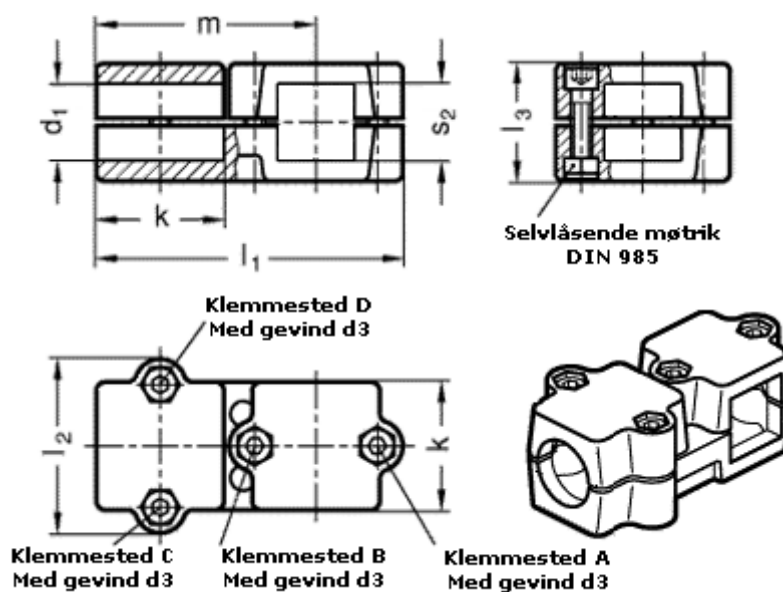

d2 = 50
d3 = M10
k = 76
l1 = 176
l2 = 98
l3 = 70
m = 126
s1 = 50